

XL7 OCS Datasheet for

HE-XW1E0, HE-XW1E2, HE-XW1E3, HE-XW1E4, HE-XW1E5
HEXT391C100, HEXT391C112, HEXT391C113, HEXT391C114, HEXT391C115

1. Specifications

General Specifications				Control & Logic Specifications						
Required Power (Steady state)	170mA @ 24VDC			Control Language Support	Advanced Ladder Logic Full IEC 1131-3 Languages					
Required Power (Inrush)	7A for <1 ms @ 24 VDC DC Switched			Logic Program Size & Logic Scan Rate	1MB, maximum 0.013mS/K					
Primary Power Range	10–30VDC			Online Programming Changes	Supported in Advanced Ladder					
Relative Humidity	5 to 95% Non-condensing			I/O Support	Digital Inputs	2048				
Clock Accuracy	+/- 20 ppm maximum at 25° C (+/- 1 Minutes per Month)				Digital Outputs	2048				
Surrounding Air Temp	-10°C to +60°C				Analog Inputs	512				
Storage Temp	-30°C to +70°C			General Purpose Registers	Analog Outputs	512				
Weight	2lb. (without I/O)				50,000 (words) Retentive 16,384 (bits) Retentive 16,384 (bits) Non-retentive					
UL / CE	US Certifications Europe Certifications									
Display Specifications				Connectivity						
Display Type	7" TFT Transmissive Color			Serial Ports	1 RS-232 & 1 RS-485 on first Modular Jack (MJ1/2) 1 RS-232 or 1 RS-485 on second Modular Jack (MJ3)					
Resolution	800x480			USB mini-B	USB 2.0 (480MHz) Programming & Data Access					
Color	16-bit (65,535)			USB A	USB 2.0 (480MHz) for USB FLASH Drives (2TB)					
Screen Memory	27 MB			CAN	Remote I/O, Peer-to-Peer Comms, Cscape					
User-Programmable Screens	1023			Ethernet	10/100 Mb (Auto-MDX), Modbus TCP C/S, HTTP, FTP, SMTP, Cscape, Ethernet IP					
Backlight	LED – 50,000 hour life			Remote I/O	SmartRail, SmartStix, SmartBlock, SmartMod					
Screen Update Rate	User Configurable within the scan time. (perceived as instantaneous in many cases)			Removable Memory	MicroSD, support for 32GB max. Application Updates, Datalogging, more					
Input / Output Specifications										
Model	DC In	DC Out	Relays	HS In	HS Out	mA/V In	mA/V RTD/Tc	mA/V Out	High-Speed Counters	
Model 2	12		6	4		4			Number of Counters	2
Model 3	12	12		4	2	2			Maximum Frequency	500 kHz each
Model 4	24	16		4	2	2			Accumulator Size	32-bits each
Model 5	12	12		4	2		2	2	Modes Supported	
There are 4 high-speed inputs of the total DC Inputs. There are 2 high-speed outputs of the total DC outputs. Model 2, 3 & 4 feature 12-bit Analog I/O. Model 5 features 14/16-bit Analog I/O. High-speed Outputs can be used for PWM and Pulse Train Outputs, currently limited to <65kHz.									Totalizer	Quadrature
									Pulse Measurement	Frequency Measurement
									2 Position Controlled Outputs 1 ON/OFF Setpoint per Output	

2. Dimensions & Panel Cutout

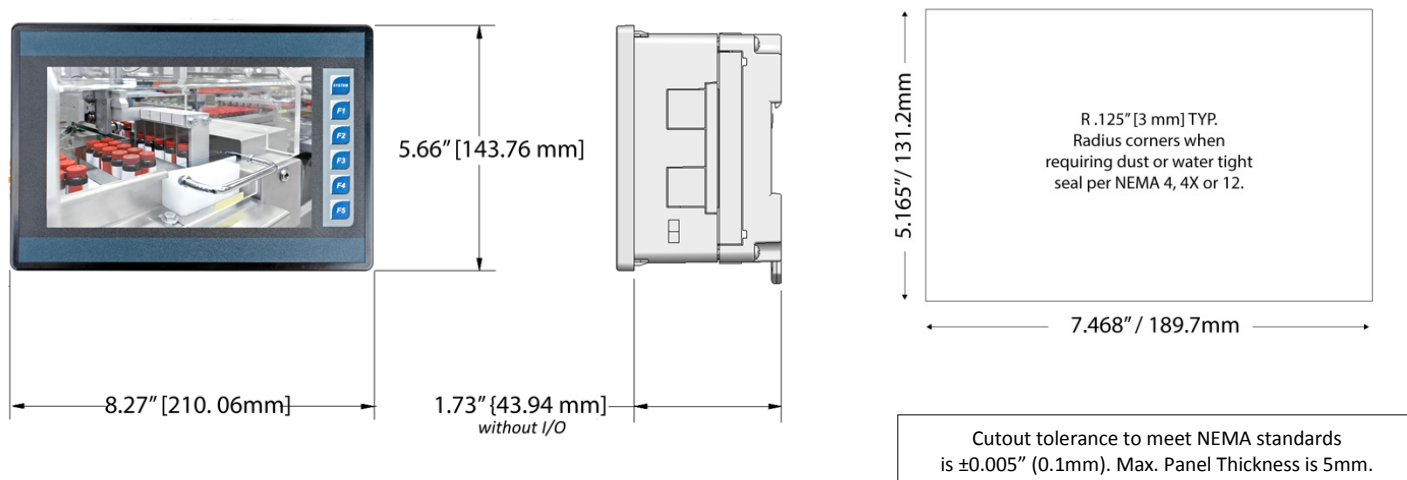

3. Installation Procedures

1. Carefully locate an appropriate place to mount the XL7. Be sure to leave enough room at the top of the unit for insertion and removal of the microSD card. Also leave enough room at the bottom for the insertion and removal of USB FLASH drives
2. Carefully cut the host panel per the diagram on Page 1, creating a 189.7mm x 131.2mm ±0.1mm opening into which the XL7 may be installed. If the opening is too large, water may leak into the enclosure, potentially damaging the XL7. If the opening is too small, the OCS may not fit through the hole without damage.
3. Remove all Removable Terminals from the XL7. Insert the XL7 through the panel cutout (from the front). The gasket needs to be between the host panel and the XL7.
4. Install and tighten the four mounting clips (provided in the box) until the gasket forms a tight seal (max torque 7-10 lb-in. [0.8 – 1.13 Nm])
5. Reinstall the XL7 I/O Removable Terminal Blocks. Connect communications cables to the serial port, USB ports, Ethernet port, and CAN port as required.

4. Ports & Connectors

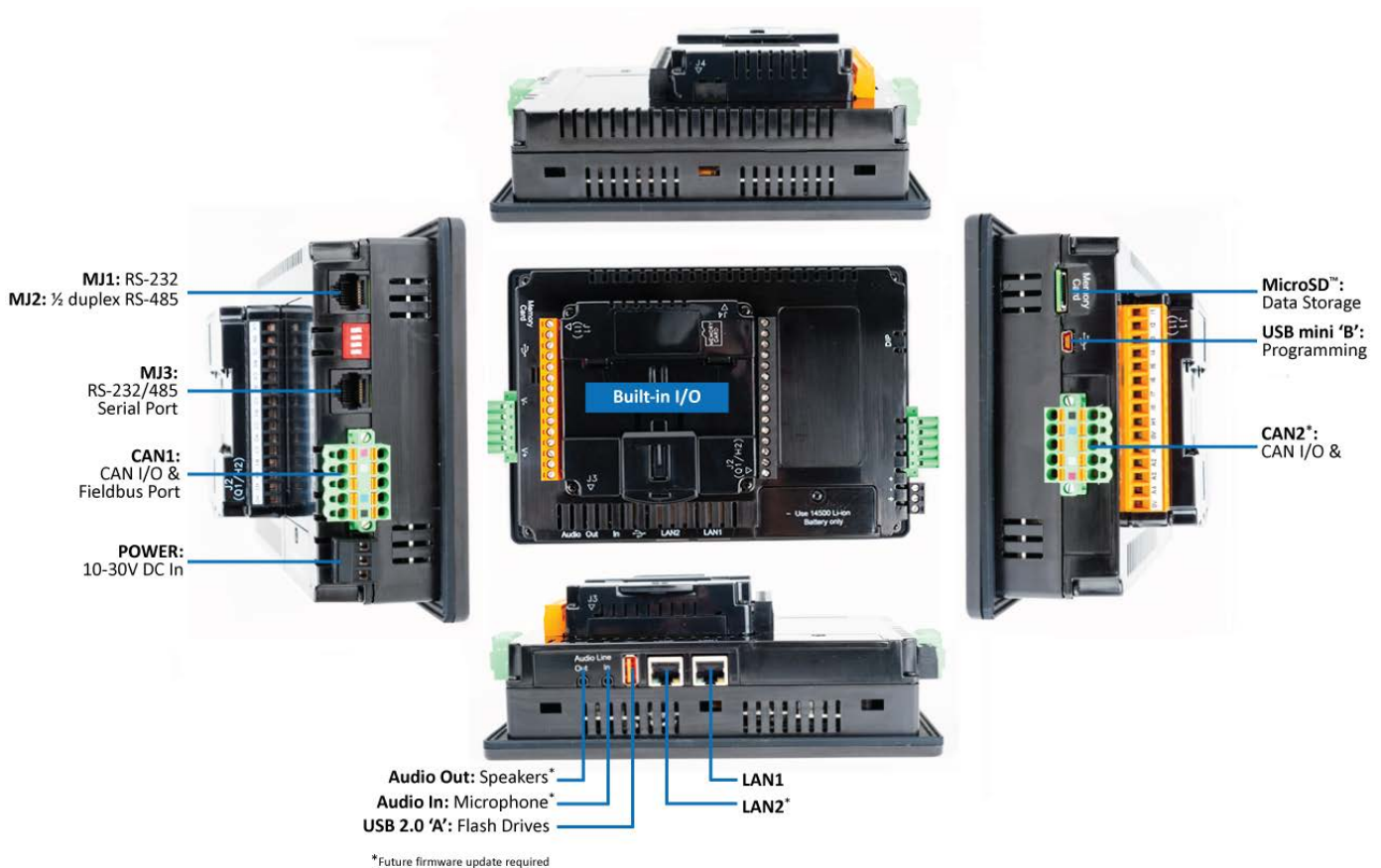

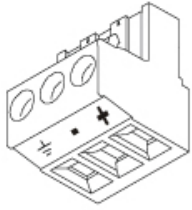

DC Input / Frame

Torque rating: 4.5 – 7 Lb-In
(0.50 – 0.78 N-m)

DC- is internally connected to I/O V-,
but is isolated from CAN V-
A Class 2 power supply must be used.

Primary Power Port Pins		
PIN	SIGNAL	DESCRIPTION
1	Ground	Frame Ground
2	DC-	Input Power Supply Ground
3	DC+	Input Power Supply Voltage

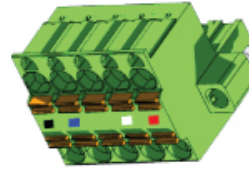

CAN

Locking Spring-Clamp,
Two-terminators Per Conductor

Torque rating: 4.5 Lb-In
(0.50 N-m)

SHLD and V+ pins are not
internally connected to XL7

CAN1 / CAN2 Port Pin			
PIN	SIGNAL	DESCRIPTION	DIRECTION
1	V-	CAN Ground - Black	—
2	CN L	CAN Data Low - Blue	IN / OUT
3	SHLD	Shield Ground - None	—
4	CN H	CAN Data High - White	IN / OUT
5	V+ (NC)	No Connect - Red	—

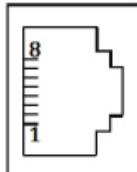

MJ1/2 Independent Serial Ports

MJ1: RS232 w/Full Handshaking

MJ2: RS485 Half-Duplex

PIN	MJ1 PINS		MJ2 PINS	
	SIGNAL	DIRECTION	SIGNAL	DIRECTION
8	TXD	OUT	—	—
7	RXD	IN	—	—
6	0 V	Ground	0 V	Ground
5	+5V@60mA	OUT	+5V@60mA	OUT
4	RTS	OUT	—	—
3	CTS	IN	—	—
2	—	—	RX- / TX-	IN / OUT
1	—	—	RX+ / TX+	IN / OUT

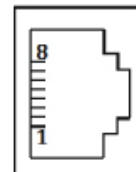

MJ3 Serial Port

Two multiplexed Serial Ports on One
Modular Jack (8posn)

PIN	MJ3 PINS	
	SIGNAL	DIRECTION
8	TXD RS232	OUT
7	RXD RS232	IN
6	0 V	Ground
5	+5V@60mA	OUT
4	TX- RS485	OUT
3	TX+ RS485	OUT
2	RX- RS485	IN
1	RX+ RS485	IN

DIP Switches

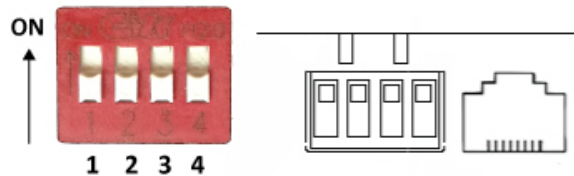

SWITCH	NAME	FUNCTION	DEFAULT
1	MJ3 RS485 Termination	ON = Terminated	OFF
2	MJ3 Duplex	ON = Half	OFF
3		OFF = Full	
4	MJ2 RS485 Termination	ON = Terminated	OFF

5. Safety

WARNING: Only qualified electrical personnel familiar with the construction and operation of this equipment and the hazards involved should install, adjust, operate, or service this equipment. Read and understand this manual and other applicable manuals in their entirety before proceeding. Failure to observe this precaution could result in severe bodily injury or loss of life.

WARNING: To avoid the risk of electric shock or burns, always connect the earth ground before making any other connections.

WARNING: To reduce the risk of fire, electrical shock, or physical injury it is strongly recommended to fuse all Power Sources connected to the OCS. Be sure to locate fuses as close to the source as possible.

WARNING: Replace fuse with the same type and rating to provide protection against risk of fire and shock hazards.

WARNING: In the event of repeated failure, do not replace the fuse again as a repeated failure indicates a defective condition that will not clear by replacing the fuse.

WARNING: Battery may explode if mistreated. Do not recharge, disassemble or dispose of in fire.

WARNING: EXPLOSION HAZARD – BATTERIES MUST ONLY BE CHANGED IN AN AREA KNOWN TO BE NON-HAZARDOUS

Power input and output (I/O) wiring must be in accordance with Class I, Division 2 wiring methods of the National Electric Code, NFPA 70 for installations in the U.S., or as specified in Section 18-1J2 of the Canadian Electrical Code for installations within Canada and in accordance with the authority having jurisdiction.

This equipment is suitable for use in Class I, Division 2, Groups A, B, C, and D or Non-hazardous locations only.

WARNING: EXPLOSION HAZARD – Do not disconnect equipment unless power has been switched off or the area is known to be non-hazardous.

WARNING: EXPLOSION HAZARD – Substitution of components may impair suitability for Class 1, Division 2.

Digital outputs shall be supplied from the same source as the Operator Control Station.

Jumpers on connector JP1 and others shall not be removed or replaced while the circuit is live unless the area is known to be free of ignitable concentrations of flammable gasses or vapors.

6. Common Cause of Analog Input Transorb Failure

A common cause of Analog Input Transorb Failure on Analog Inputs Model 2, 3, 4 & 5: If a 4-20mA circuit is initially wired with loop power, but without a load, the Analog input could see 24Vdc. This is higher than the rating of the transorb. This can be solved by NOT connecting loop power prior to load connection, or by installing a low-cost PTC in series between the load and Analog input. See SUP0977-01 for additional details.

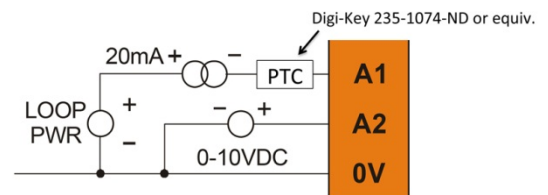

NOTE†: Refers to Model 2 – orange (pg.5,) Models 3 & 4 – J1 (pg.6) and Model 5 – 20mA Analog In (pg.7.)

7. Technical Support

For assistance and manual updates, contact Technical Support at the following locations:

North America

(317) 916-4274

Toll Free: 877-665-5666

<http://www.heapg.com>

e-mail: techsppt@heapg.com

Europe

(+) 353-21-4321-266

<http://www.horner-apg.com>

e-mail: tech.support@horner-apg.com

8. Built-in I/O (Model 2, 3, 4 & 5)

All XL7 models (except the HE-XW1E0) feature built-in I/O. The I/O is mapped into OCS Register space, in three separate areas – Digital/Analog I/O, High-Speed Counter I/O, and High-speed Output I/O. Digital/Analog I/O location is fixed starting at 1, but the High-speed Counter and High-speed Output references may be mapped to any open register location. For more details on using the High-Speed Counter and High-Speed Outputs, see the XL7 OCS User’s Manual (MAN0974-01).

Fixed Address	Digital/Analog I/O Function	XL7 Model			
		2	3	4	5
%I1	Digital Inputs	1-12	1-12	1-24	1-12
	Reserved	13-32	13-31	25-31	13-31
	ESCP Alarm	n/a	32	32	32
%Q1	Digital Outputs	1-6	1-12	1-16	1-12
	Reserved	7-24	13-24	17-24	13-24
%AI1	Analog Inputs	1-4	1-2	1-2	1-2
	Reserved	5-12	3-12	3-12	3-12
	Reserved	n/a	1-8	1-8	1-8
%AQ1	Analog Outputs	n/a	n/a	n/a	9-10
	Reserved areas maintain backward compatibility with other XL Series OCS models				

Default Address*	High-Speed Counter Function	XL7 Models 2-5
%I1601	Status Bits	1-8
%Q1601	Command Bits	1-32
%AI0401	Accumulator 1 & 2	1-8
%AQ0401	Preload & Match Values	1-12

*Starting Address locations for %I, %Q, %AI & %AQ may be re-mapped by user

Default Address*	High-Speed Output Function	XL7 Models 2-5
%I1617	Status Bits	1-8
%Q1**	Command Bits	1-2
n/a	n/a	n/a
%AQ421	PWM or Pulse-Train Parameters	1-20

*Starting Address locations for %I & %AQ may be remapped by user

**Q1-Q2 are part of the Fixed I/O Map. In High-Speed Output mode they can be used to initiate a Stepper/PTO Move

Model 2 – I/O

The XL7 model 2 (HE-XW1E2) features 12 DC Inputs, 6 Relay outputs, and 4 Analog Inputs. The DC Inputs are 12/24Vdc compatible, and can be jumpered for Positive Logic (sinking), or Negative Logic (sourcing). Two of the inputs (H1-H2) can be used for high-speed functions up to 500kHz. The 12-bit Analog Inputs can be jumpered for voltage (0-10V) or current (4-20mA) on a channel by channel basis. The Relay outputs are isolated, supporting AC and DC voltages, with output currents of up to 3A/relay, 5A total.

J1 (Orange)	Name
I1	IN1
I2	IN2
I3	IN3
I4	IN4
I5	IN5
I6	IN6
I7	IN7
I8	IN8
H1	HSC1 / N9
0V	Common
A1	Analog IN1
A2	Analog IN2
A3	Analog IN3
A4	Analog IN4
0V	Common

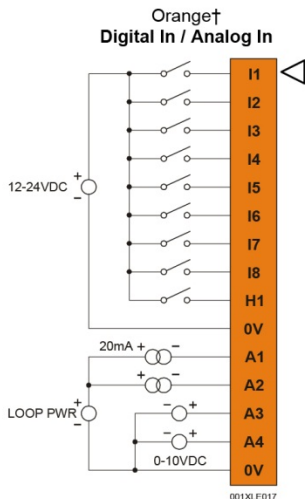

J2 (Black)	Name
C6	Relay 6 COM
R6	Relay 6 NO
C5	Relay 5 COM
R5	Relay 5 NO
C4	Relay 4 COM
R4	Relay 4 NO
C3	Relay 3 COM
R3	Relay 3 NO
C2	Relay 2 COM
R2	Relay 2 NO
C1	Relay 1 COM
R1	Relay 1 NO
H4	HSC4 / IN12
H3	HSC3 / IN11
H2	HSC2 / IN10

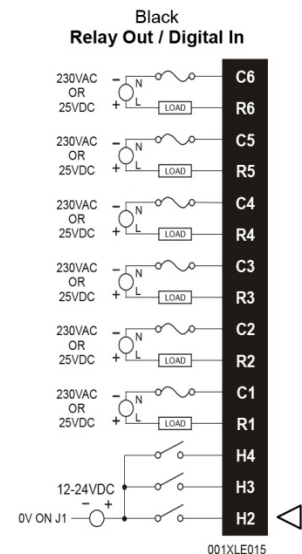

Model 2 Jumper Setting Details

J1 Digital DC In / HSC

Positive Logic

Default

Negative Logic

001XLE026

J2 Analog In (A1 – A4)

Current (20 mA)

Default

Voltage (10 V)

001XLE027

Note: The Cscape Module Setup configuration must match the selected I/O (JP) jumper settings.

Note: When using JP2 (A1-A4), each channel can be independently configured.

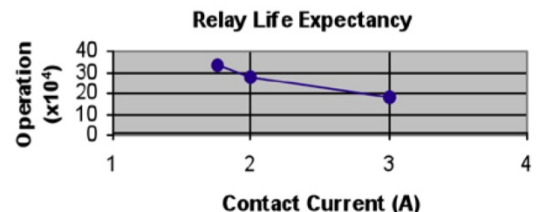

WARNING: EXPOSURE TO SOME CHEMICALS MAY DEGRADE THE SEALING PROPERTIES OF MATERIALS USED IN THE Tyco relay PCJ

Cover / case & base: Mitsubishi engineering Plastics Corp.
5010GN6-30 or 5010GN6-30 M8 (PBT)
Sealing Material: Kishimoto 4616-50K (I part epoxy resin)

It is recommended to periodically inspect the relay for any degradation of properties and replace if degradation is found

Model 3 & 4 – I/O

The XL7 model 3 (HE-XW1E3) features 12 DC Inputs, 12 DC outputs, and 2 Analog Inputs. The XL7 model 4 (HE-XW1E4) increases the I/O count up to 24 DC Inputs, and 16 DC Outputs and 2 Analog Inputs. The DC Inputs are 12/24Vdc compatible, and can be jumpered for Positive Logic (sinking), or Negative Logic (sourcing). Two of the inputs (H1-H2) can be used for high-speed functions up to 500kHz. The 12-bit Analog Inputs can be jumpered for voltage (0-10V) or current (4-20mA) on a channel by channel basis. The 12/24VDC Outputs feature Electronic Short Circuit protection, and support currents up to 0.5A per point, and 4A total. Two of the DC Outputs can be used for high speed functions (PWM or PTO). The output frequency is limited by the switching capability of the output drivers (about 10kHz), although an optional accessory (HE-XHSQ) can be added to provide parallel output drivers supporting frequencies up to 200kHz.

J1 (Orange)	Model 3 & 4 Signal Name
I1	IN1
I2	IN2
I3	IN3
I4	IN4
I5	IN5
I6	IN6
I7	IN7
I8	IN8
H1	HSC1 / IN9
H2	HSC2 / IN10
H3	HSC3 / IN11
H4	HSC4 / IN12
A1	Analog IN1
A2	Analog IN2
0V	Common

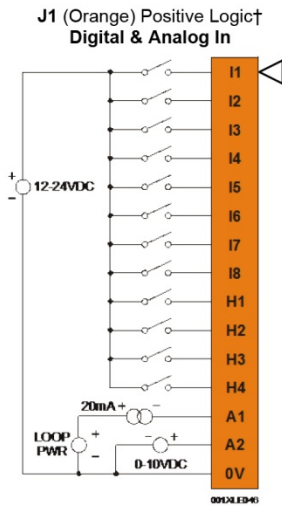

J3 (Orange)	Model 4 only Signal Name
I13	IN13
I14	IN14
I15	IN15
I16	IN16
I17	IN17
I18	IN18
I19	IN19
I20	IN20
I21	IN21
I22	IN22
I23	IN23
I24	IN24
0V	Common

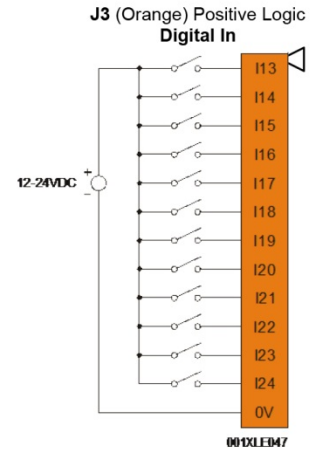

J2 (Black)	Model 3 Name	Model 4 Name
0V	Common	
V+	V+ *	
NC	No Connect	OUT13
Q12	OUT12	
Q11	OUT11	
Q10	OUT10	
Q9	OUT9	
Q8	OUT8	
Q7	OUT7	
Q6	OUT6	
Q5	OUT5	
Q4	OUT4	
Q3	OUT3	
Q2	OUT2 / PWM2	
Q1	OUT1 / PWM1	

*V+ Supply for Sourcing Outputs

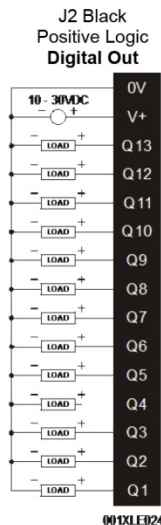

Jumper Setting Details

Location of I/O jumpers (JP1 & JP3) and wiring connectors (J1, J2, J3 & J4) with back cover removed.

JP1 Digital DC Inputs

Positive Logic:

Negative Logic:

Default:

JP3 Analog Inputs

20mA

A1 1 2

A2 3 4

10VDC

A1 1 2

A2 3 4

Note: The Cscope Module Setup configuration must match the selected I/O (JP) jumper settings.

Note: When using JP3 (A1-A2), each channel can be independently configured.

J4 (Orange)	Model 4 Name
Q16	OUT16
Q15	OUT15
Q14	OUT14

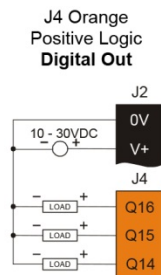

Note:
Model 3 uses
J1 & J2 only.

Model 4 uses
J1, J2, J3 & J4.

Model 5 – I/O

The XL7 model 5 (HE-XW1E5) features 12 DC Inputs, 12 DC outputs, with high performance, highly configurable Analog Inputs (2) and Analog Outputs (2). The DC Inputs are 12/24Vdc compatible, and can be jumpered for Positive Logic (sinking), or Negative Logic (sourcing). Two of the inputs (H1-H2) can be used for high-speed functions up to 500kHz. The 12/24VDC Outputs feature Electronic Short Circuit protection, and support currents up to 0.5A per point, and 4A total. Two of the DC Outputs can be used for high speed functions (PWM or PTO). The output frequency is limited by the switching capability of the output drivers (about 10kHz), although an optional accessory (HE-XHSQ) can be added to provide parallel output drivers supporting frequencies up to 200kHz.

The two high resolution Analog Inputs can be configured for 4-20mA, 0-10V, or 0-100mV at 14-bit resolution. They also can be configured for 16-bit temperature measurement – supporting Thermocouples or RTDs with 0.05°C resolution. The Analog Outputs are sourcing, and can be configured for 4-20mA or 0-10V at 14-bit resolution. Each Analog Input or Output channel can be configured independently for maximum flexibility.

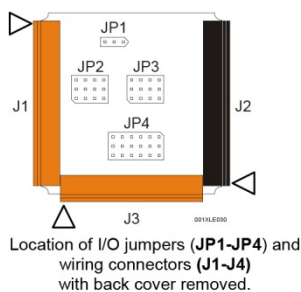
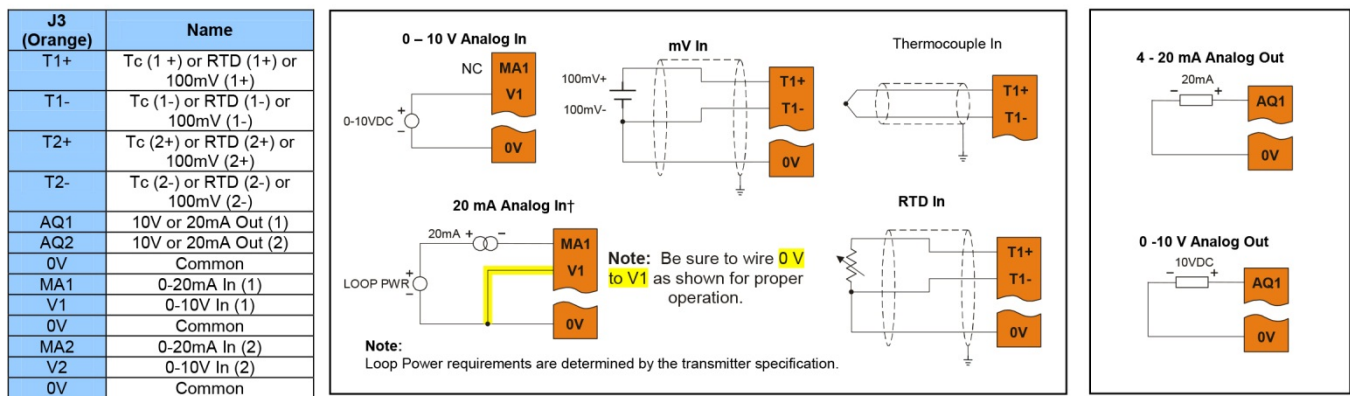
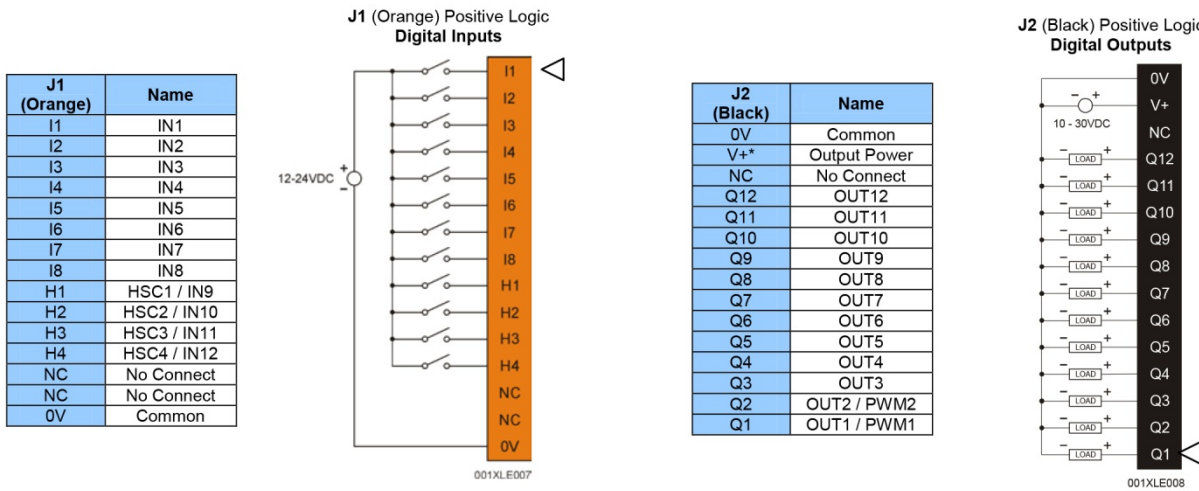

Jumper Setting Details

